



SPIDER[®]
SHELVING SYSTEM

THE MOST VERSATILE SHELVING SYSTEM THAT EXISTS

Much more than a simple shelving unit!

Sturdy construction and quick assembly, the Spider[®] shelving system meets all of your storage needs. With its vast range of accessories, it offers the most diverse options on the market, making finding solutions for all your storage problems as easy as 1, 2, 3.



R5XEC-2004

- The combination of shelving and Mini-Racking opens up a whole new avenue of possibilities;
- Adding modular drawers guarantees you secure organization of all your small parts;
- Vertical expansion is also a possibility thanks to our two-level shelving system.

Designed for intensive use, our modular storage system will maximize the space in your warehouse, parts department, maintenance workshop, distribution center, etc.

Our expertise ensures you peace of mind for all of your needs, present and future!

Spider® Shelving System

The Rousseau Advantages

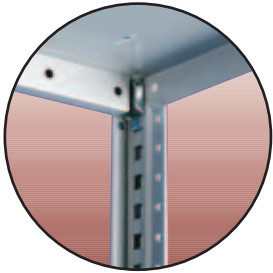

Assembly is simple : shelves are installed on the posts using 4 compression clips, in 14 gauge steel. This makes for easy and fast adjustments.

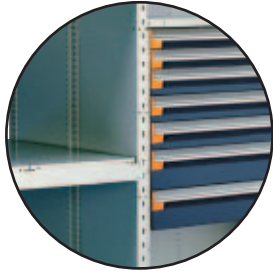

Mini-Racking integrated into your shelving optimizes your storage possibilities.

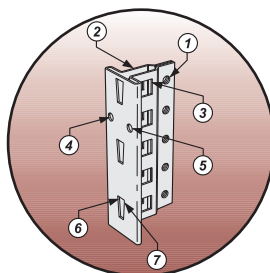

A unique and super functional post. The common post is the cornerstone of the structure. Its unique T-shape offers up to 7 fixing zones for different applications. Plus, its hollow center makes for installations without interference.

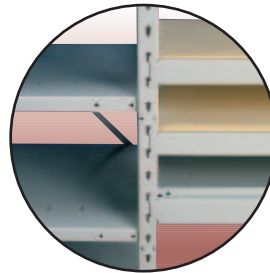

The steel beams are designed for several types of decking : wood, steel and wire. Two types of beams are available, depending on the load capacity and dimensions required. Load capacity can reach 1925 lb.



Each component is designed to offer you an easy-to-use product.

General Dimensions

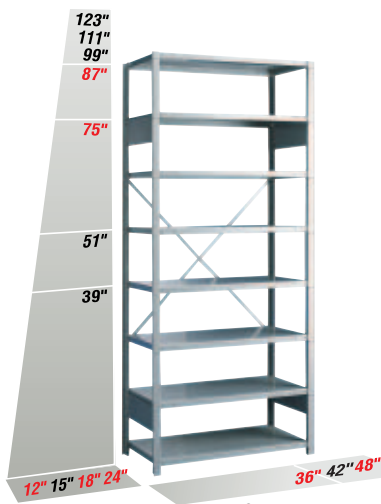

SHE1024

Popular dimensions shown in red.



SRE5127S

Index	Page(s)
Spider® Shelving System	50 - 51
Industrial Shelving	
Proposals	52 - 56
Accessories	57 - 62
Components	63 - 65
Mini-Racking	
Proposals	66 - 67
Accessories	68
Components	69 - 71

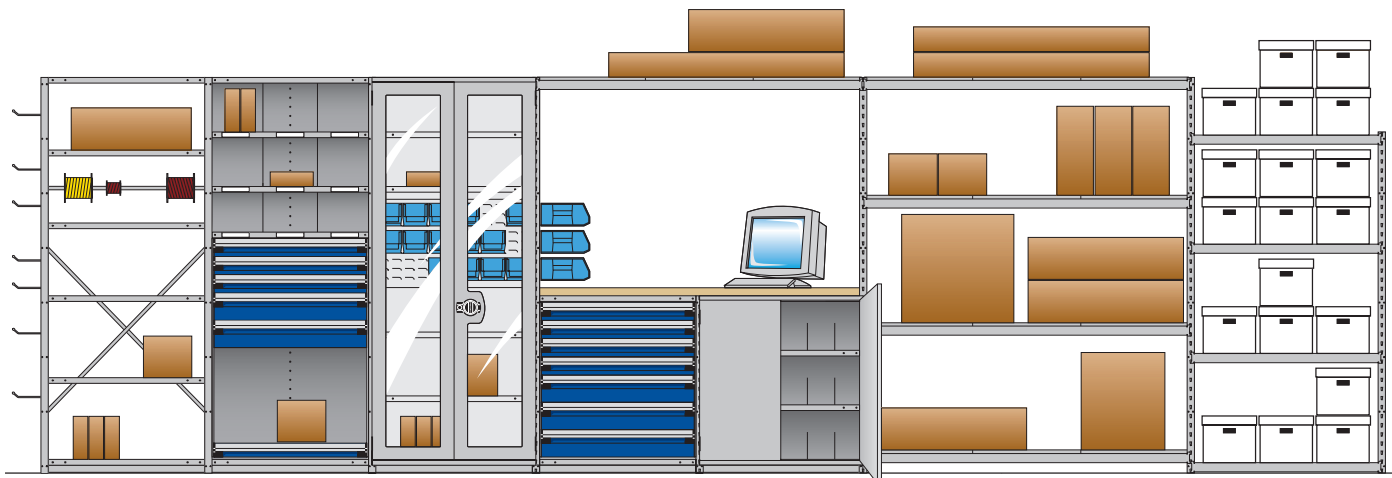



SHE1024



SHE2024

When ordering, model numbers must be completed as follows:



H for posts with smooth finish surface

R for posts with perforated surface

EXAMPLE: **S**

1001

	Starter Unit	Add-on Unit
BOLTED uprights	D	A
WELDED uprights	E	B

Example : **SH D 1 0 0 1**

For a model with smooth finish posts and bolted uprights

Open and Closed Shelving : 36", 42" and 48" Wide

Open Shelving

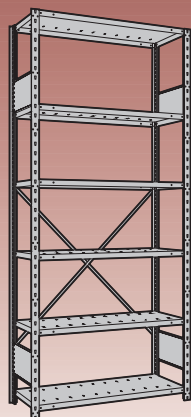

SRE1011
Starter

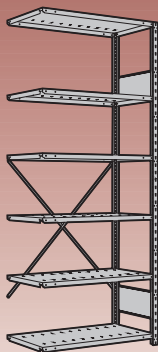

SRB1011
Add-on

Dimensions			Number of Shelves			
W	D	H	5	6	7	8
36"	12"	75"	S_1001	S_1007	S_1013	S_1019
			S_1002	S_1008	S_1014	S_1020
			S_1003	S_1009	S_1015	S_1021
	18"	87"	S_1004	S_1010	S_1016	S_1022
			S_1005	S_1011	S_1017	S_1023
			S_1006	S_1012	S_1018	S_1024
42"	12"	75"	S_1131	S_1137	S_1143	S_1149
			S_1132	S_1138	S_1144	S_1150
			S_1133	S_1139	S_1145	S_1151
	18"	87"	S_1134	S_1140	S_1146	S_1152
			S_1135	S_1141	S_1147	S_1153
			S_1136	S_1142	S_1148	S_1154
48"	12"	75"	S_1031	S_1037	S_1043	S_1049
			S_1032	S_1038	S_1044	S_1050
			S_1033	S_1039	S_1045	S_1051
	18"	87"	S_1034	S_1040	S_1046	S_1052
			S_1035	S_1041	S_1047	S_1053
			S_1036	S_1042	S_1048	S_1054

Closed Shelving

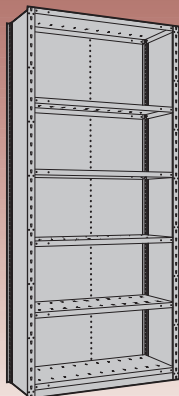

SRE2011
Starter

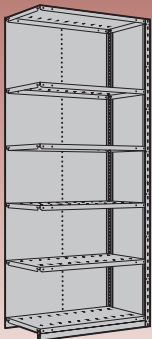

SRB2011
Add-on

Dimensions			Number of Shelves			
W	D	H	5	6	7	8
36"	12"	75"	S_2001	S_2007	S_2013	S_2019
			S_2002	S_2008	S_2014	S_2020
			S_2003	S_2009	S_2015	S_2021
	18"	87"	S_2004	S_2010	S_2016	S_2022
			S_2005	S_2011	S_2017	S_2023
			S_2006	S_2012	S_2018	S_2024
42"	12"	75"	S_2131	S_2137	S_2143	S_2149
			S_2132	S_2138	S_2144	S_2150
			S_2133	S_2139	S_2145	S_2151
	18"	87"	S_2134	S_2140	S_2146	S_2152
			S_2135	S_2141	S_2147	S_2153
			S_2136	S_2142	S_2148	S_2154
48"	12"	75"	S_2031	S_2037	S_2043	S_2049
			S_2032	S_2038	S_2044	S_2050
			S_2033	S_2039	S_2045	S_2051
	18"	87"	S_2034	S_2040	S_2046	S_2052
			S_2035	S_2041	S_2047	S_2053
			S_2036	S_2042	S_2048	S_2054

*Front base is included with closed shelving.

Industrial Shelving Proposals

Back-to-Back Open and Closed Shelving : 36" , 42" and 48" Wide

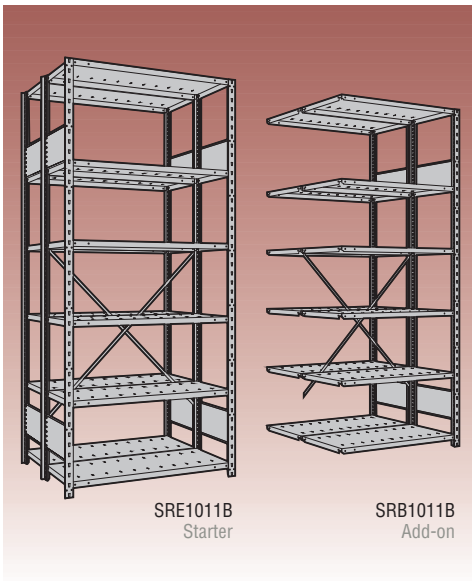

SRE1011B
Starter

SRB1011B
Add-on

Open Shelving

Dimensions			Number of Shelves				
W	D	H	10	12	14	16	
36"	24"	75"	S_1001B	S_1007B	S_1013B	S_1019B	
			S_1002B	S_1008B	S_1014B	S_1020B	
			S_1003B	S_1009B	S_1015B	S_1021B	
	24"	87"	S_1004B	S_1010B	S_1016B	S_1022B	
			S_1005B	S_1011B	S_1017B	S_1023B	
			S_1006B	S_1012B	S_1018B	S_1024B	
	42"	24"	75"	S_1131B	S_1137B	S_1143B	S_1149B
				S_1132B	S_1138B	S_1144B	S_1150B
				S_1133B	S_1139B	S_1145B	S_1151B
24"		87"	S_1134B	S_1140B	S_1146B	S_1152B	
			S_1135B	S_1141B	S_1147B	S_1153B	
			S_1136B	S_1142B	S_1148B	S_1154B	
48"		24"	75"	S_1031B	S_1037B	S_1043B	S_1049B
				S_1032B	S_1038B	S_1044B	S_1050B
				S_1033B	S_1039B	S_1045B	S_1051B
	24"	87"	S_1034B	S_1040B	S_1046B	S_1052B	
			S_1035B	S_1041B	S_1047B	S_1053B	
			S_1036B	S_1042B	S_1048B	S_1054B	

SPIDER®
SHELVING SYSTEM

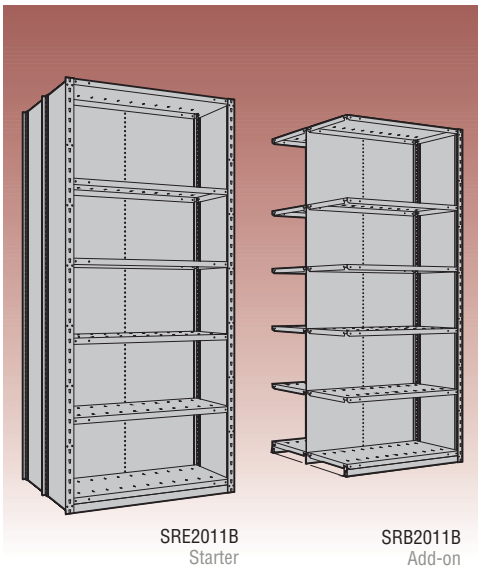

SRE2011B
Starter

SRB2011B
Add-on

Closed Shelving

Dimensions			Number of Shelves				
W	D	H	10	12	14	16	
36"	24"	75"	S_2001B	S_2007B	S_2013B	S_2019B	
			S_2002B	S_2008B	S_2014B	S_2020B	
			S_2003B	S_2009B	S_2015B	S_2021B	
	24"	87"	S_2004B	S_2010B	S_2016B	S_2022B	
			S_2005B	S_2011B	S_2017B	S_2023B	
			S_2006B	S_2012B	S_2018B	S_2024B	
	42"	24"	75"	S_2131B	S_2137B	S_2143B	S_2149B
				S_2132B	S_2138B	S_2144B	S_2150B
				S_2133B	S_2139B	S_2145B	S_2151B
24"		87"	S_2134B	S_2140B	S_2146B	S_2152B	
			S_2135B	S_2141B	S_2147B	S_2153B	
			S_2136B	S_2142B	S_2148B	S_2154B	
48"		24"	75"	S_2031B	S_2037B	S_2043B	S_2049B
				S_2032B	S_2038B	S_2044B	S_2050B
				S_2033B	S_2039B	S_2045B	S_2051B
	24"	87"	S_2034B	S_2040B	S_2046B	S_2052B	
			S_2035B	S_2041B	S_2047B	S_2053B	
			S_2036B	S_2042B	S_2048B	S_2054B	

*Front base is included with closed shelving.

87" High Closed Shelving with Accessories

SPIDER®
SHELVING SYSTEM



Shelving with Dividers
8 shelves
28 openings :
- 28 op. 12" x 9"
21 dividers, 5 1/2" high

SRE3009 Starter
SRB3009 Add-on

Product #	W x D
S_ 3008	36" x 12"
S_ 3009	36" x 18"
S_ 3010	36" x 24"

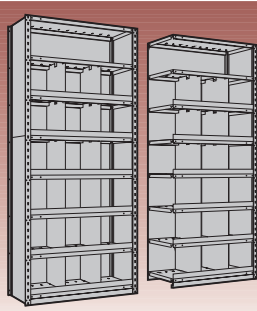

Shelving with Dividers
8 shelves
19 openings :
- 18 op. 12" x 12"
- 1 op. 36" x 12"
12 dividers, 12" high
6 shelf fronts

SRE3022 Starter
SRB3022 Add-on

Product #	W x D
S_ 3021	36" x 12"
S_ 3022	36" x 18"
S_ 3023	36" x 24"

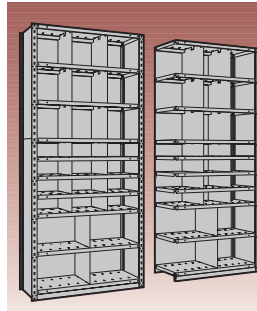

Shelving with Dividers
10 shelves
25 openings :
- 9 op. 12" x 12"
- 12 op. 12" x 6"
- 4 op. 18" x 12"
8 dividers, 6" high
8 dividers, 12" high

SRE3032 Starter
SRB3032 Add-on

Product #	W x D
S_ 3031	36" x 12"
S_ 3032	36" x 18"
S_ 3033	36" x 24"

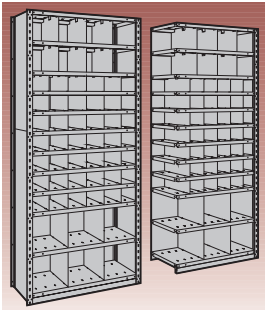

Shelving with Dividers
12 shelves
56 openings :
- 8 op. 9" x 9"
- 42 op. 6" x 6"
- 6 op. 12" x 12"
35 dividers, 6" high
6 dividers, 9" high
4 dividers, 12" high

SRE3052 Starter
SRB3052 Add-on

Product #	W x D
S_ 3051	36" x 12"
S_ 3052	36" x 18"
S_ 3053	36" x 24"

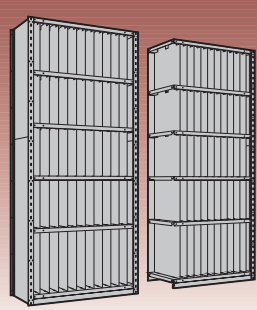

Shelving with Dividers for X-ray Files
6 shelves
60 openings :
- 48 op. 3" x 16"
- 12 op. 3" x 20"
44 dividers, 16" high
11 dividers, 20" high

SRE3062 Starter
SRB3062 Add-on

Product #	W x D
S_ 3062	36" x 18"

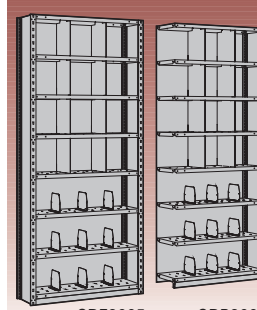

Shelving with Dividers
8 shelves
8 dividers, 12" high
9 dividers, 5 1/2" high

SRE3005 Starter
SRB3005 Add-on

Product #	W x D
S_ 3004	36" x 12"
S_ 3005	36" x 18"
S_ 3006	36" x 24"

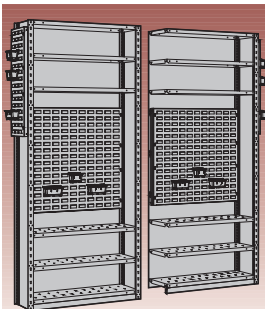

Shelving with Accessories
6 shelves
2 louvered panels
6 plastic bins

SRE3202 Starter
SRB3202 Add-on

Product #	W x D
S_ 3201	36" x 12"
S_ 3202	36" x 18"
S_ 3203	36" x 24"

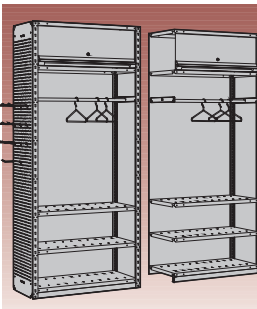

Shelving with Accessories
5 shelves
1 flipper door
1 clothes hanging rail
1 perforated panel
10 hooks

SRE3209 Starter
SRB3209 Add-on

Product #	W x D
S_ 3209	36" x 18"
S_ 3210	36" x 24"



Industrial Shelving Proposals

Shown here are some of the most popular drawers in shelving models.

All models include welded closed upright and hook-on mounting brackets for Spider® shelving, allowing for quick and easy assembly;

Additional accessories available : panels (perforated, louvered and finishing panels), shelf dividers, doors, etc.;

To order an add-on unit, complete product number with A.

SEE
PAGES
57-62



R5XEE-2001

SPIDER®
SHELVING SYSTEM

IMPORTANT Drawer partitions are included in models.

For drawers without partitioning, refer to the price list
Ex. : R5SEC-751801 with
R5SEC-751802 without

Shelving with drawers must be anchored to the floor (anchoring kit included).

Number of Compartments (layout code)						
Drawer dimensions	36" x 18"	36" x 24"	42" x 18"	42" x 24"	48" x 18"	48" x 24"
3" to 5"	24 (0518)	30 (0524)	20 (0512)	30 (0524)	32 (0724)	40 (0732)
6" to 8"	8 (0304)	12 (0308)	12 (0308)	12 (0308)	10 (0405)	15 (0410)
9" and higher	6 (0203)	9 (0206)	6 (0203)	8 (0304)	8 (0304)	8 (0304)

NOTE For inside drawer dimensions, see pages 126 -127.

Shelving with 18", 24", 36" & 48" of Modular Drawers

Shelving with 18" of Modular Drawers



R5SEE-871801

4 drawers :
- 3-4" drawers
- 1-6" drawer

75" H (5 shelves) or 87" H (6 shelves) shelving

W x D	75" H	87" H
36" x 18"	R5SEC-751801	R5SEC-871801
36" x 24"	R5SEE-751801	R5SEE-871801
42" x 18"	R5SGC-751801	R5SGC-871801
42" x 24"	R5SGE-751801	R5SGE-871801
48" x 18"	R5SHC-751801	R5SHC-871801
48" x 24"	R5SHE-751801	R5SHE-871801

Shelving with 24" of Modular Drawers



R5SEE-872401

5 drawers :
- 3-4" drawers
- 2-6" drawers

75" H (5 shelves) or 87" H (6 shelves) shelving

W x D	75" H	87" H
36" x 18"	R5SEC-752401	R5SEC-872401
36" x 24"	R5SEE-752401	R5SEE-872401
42" x 18"	R5SGC-752401	R5SGC-872401
42" x 24"	R5SGE-752401	R5SGE-872401
48" x 18"	R5SHC-752401	R5SHC-872401
48" x 24"	R5SHE-752401	R5SHE-872401

Shelving with 36" of Modular Drawers



R5SEE-873601

7 drawers :
- 3-4" drawers
- 4-6" drawers

75" H (5 shelves) or 87" H (6 shelves) shelving

W x D	75" H	87" H
36" x 18"	R5SEC-753601	R5SEC-873601
36" x 24"	R5SEE-753601	R5SEE-873601
42" x 18"	R5SGC-753601	R5SGC-873601
42" x 24"	R5SGE-753601	R5SGE-873601
48" x 18"	R5SHC-753601	R5SHC-873601
48" x 24"	R5SHE-753601	R5SHE-873601



R5SEE-873603

7 drawers :
- 4-4" drawers
- 2-6" drawers
- 1-8" drawer

75" H (5 shelves) or 87" H (6 shelves) shelving

W x D	75" H	87" H
36" x 18"	R5SEC-753603	R5SEC-873603
36" x 24"	R5SEE-753603	R5SEE-873603
42" x 18"	R5SGC-753603	R5SGC-873603
42" x 24"	R5SGE-753603	R5SGE-873603
48" x 18"	R5SHC-753603	R5SHC-873603
48" x 24"	R5SHE-753603	R5SHE-873603

Shelving with 48" of Modular Drawers

SPIDER®
SHELVING SYSTEM



R5SEE-874801

8 drawers :
- 8-6" drawers
75" H (4 shelves) or 87" H (5 shelves) shelving

W x D	75" H	87" H
36" x 18"	R5SEC-754801	R5SEC-874801
36" x 24"	R5SEE-754801	R5SEE-874801
42" x 18"	R5SGC-754801	R5SGC-874801
42" x 24"	R5SGE-754801	R5SGE-874801
48" x 18"	R5SHC-754801	R5SHC-874801
48" x 24"	R5SHE-754801	R5SHE-874801



R5SEE-874803

9 drawers :
- 4-4" drawers
- 4-6" drawers
- 1-8" drawer
75" H (4 shelves) or 87" H (5 shelves) shelving

W x D	75" H	87" H
36" x 18"	R5SEC-754803	R5SEC-874803
36" x 24"	R5SEE-754803	R5SEE-874803
42" x 18"	R5SGC-754803	R5SGC-874803
42" x 24"	R5SGE-754803	R5SGE-874803
48" x 18"	R5SHC-754803	R5SHC-874803
48" x 24"	R5SHE-754803	R5SHE-874803



R5SEE-874805

10 drawers :
- 6-4" drawers
- 4-6" drawers
75" H (4 shelves) or 87" H (5 shelves) shelving

W x D	75" H	87" H
36" x 18"	R5SEC-754805	R5SEC-874805
36" x 24"	R5SEE-754805	R5SEE-874805
42" x 18"	R5SGC-754805	R5SGC-874805
42" x 24"	R5SGE-754805	R5SGE-874805
48" x 18"	R5SHC-754805	R5SHC-874805
48" x 24"	R5SHE-754805	R5SHE-874805



R5SEE-874807

11 drawers :
- 4-3" drawers
- 3-4" drawers
- 4-6" drawers
75" H (4 shelves) or 87" H (5 shelves) shelving

W x D	75" H	87" H
36" x 18"	R5SEC-754807	R5SEC-874807
36" x 24"	R5SEE-754807	R5SEE-874807
42" x 18"	R5SGC-754807	R5SGC-874807
42" x 24"	R5SGE-754807	R5SGE-874807
48" x 18"	R5SHC-754807	R5SHC-874807
48" x 24"	R5SHE-754807	R5SHE-874807



R5SEE-874809

7 drawers :
- 2-3" drawers
- 3-4" drawers
- 2-6" drawers
1 front access roll-out shelf
75" H (4 shelves) or 87" H (5 shelves) shelving

W x D	75" H	87" H
36" x 18"	R5SEC-754809	R5SEC-874809
36" x 24"	R5SEE-754809	R5SEE-874809
42" x 18"	R5SGC-754809	R5SGC-874809
42" x 24"	R5SGE-754809	R5SGE-874809
48" x 18"	R5SHC-754809	R5SHC-874809
48" x 24"	R5SHE-754809	R5SHE-874809

Industrial Shelving Accessories

Dividers

Shelf Divider

SH50

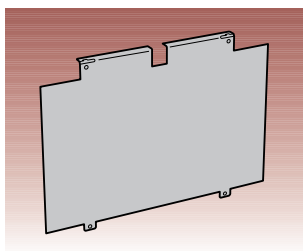

Dividers are attached one into the other;
2 nylon clips provided with each divider;



Nominal dimensions (c/c with shelves);
Offered in painted steel.

Product #	D x H
SH50-1206	12" x 6"
SH50-1209	12" x 9"
SH50-1212	12" x 12"
SH50-1215	12" x 15"
SH50-1218	12" x 18"
SH50-1506	15" x 6"
SH50-1512	15" x 12"
SH50-1806	18" x 6"
SH50-1809	18" x 9"
SH50-1812	18" x 12"
SH50-1815	18" x 15"
SH50-1818	18" x 18"
SH50-1824	18" x 24"

Product #	D x H
SH50-2406	24" x 6"
SH50-2409	24" x 9"
SH50-2412	24" x 12"
SH50-2415	24" x 15"
SH50-2418	24" x 18"
SH50-2424	24" x 24"

Dividers for X-ray Storage

SH50-1816	18" x 16"
SH50-1820	18" x 20"

Other sizes available. Contact your customer service representative for further information.

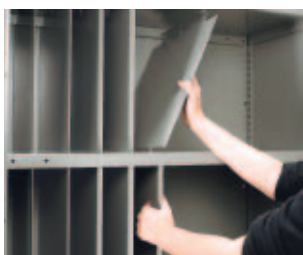

SHE3062

Partial Divider

PATENTED

SH52

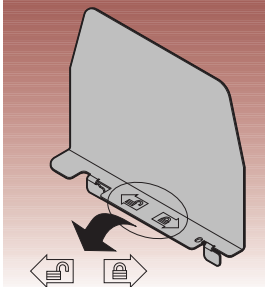

Pictograms make installation easy



Innovative patented divider, facilitates easy position changes;

Height : 5 1/2";

Easy installation, without tools.

Product #	Divider Depth	For Shelves
SH52-1206	7 1/8"	12" D
SH52-1506	10 1/8"	15" D
SH52-1806	13 1/8"	18" D
SH52-2406	19 1/8"	24" D

Dividing Rods

SH56

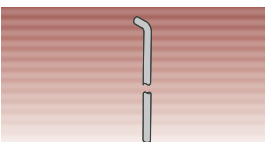

Sold in pairs;

Steel rod with 1/4" diameter;

90° fold at one end to ensure it stays in place;

Superior rigidity to plastic rods currently used on the market for this type of application.

Product #	Height
SH56-72	72"
SH56-84	84"
SH56-96	96"



SRP0410

Label Holders

Magnetic Label Holder

SH82



Magnetic plastic;

Comes in 6" lengths and can be cut with scissors or a knife;

Note : Paper strips are not included with label holder.

Product #	W x H
SH82-600	6" x 1"

Self-Adhesive Label Holder

SH81



Attaches to surface with self-adhesive strip;

To be used with paper;

Full width;

Note : Paper strips are not included with label holder.

Product #	W x H
SH81-36	36" x 1"
SH81-42	42" x 1"
SH81-48	48" x 1"

Panels and Doors

Finishing Panel



SH37

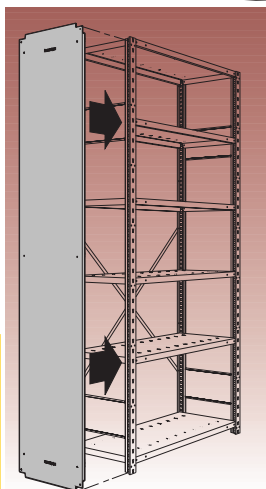

Finishing panel for end of aisle unit;
Fast and easy hook-on assembly;
Polished look;
Compatible with two-level shelving applications.

Product #	D x H
SH37-12075	12" x 75"
SH37-12087	12" x 87"
SH37-12099	12" x 99"
SH37-18075	18" x 75"
SH37-18087	18" x 87"
SH37-18099	18" x 99"
SH37-24075	24" x 75"
SH37-24087	24" x 87"
SH37-24099	24" x 99"

Perforated Panel



SH38

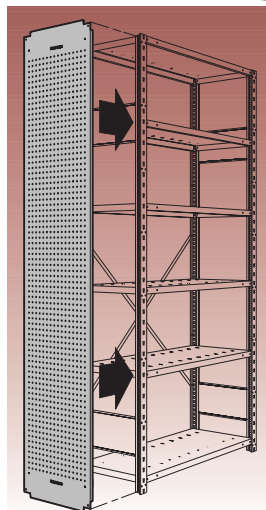

Perforated panel for end of aisle unit;
Holes at every inch c/c;
Compatible with WM94, WM95, WM96, WM97, WM98 and WM99 hooks;
Fast and easy hook-on assembly;
Polished look;
Compatible with two-level shelving applications.

Product #	D x H
SH38-12075	12" x 75"
SH38-12087	12" x 87"
SH38-12099	12" x 99"
SH38-18075	18" x 75"
SH38-18087	18" x 87"
SH38-18099	18" x 99"
SH38-24075	24" x 75"
SH38-24087	24" x 87"
SH38-24099	24" x 99"

Back or Side Louvered Panel

SH65 / SH66

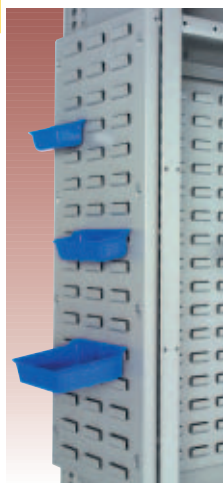

SH65 louvered panel for back of shelving : installs on the inside of the shelving unit, between two shelves;
SH66 louvered panel for side of shelving : installs on either the inside or the outside of the upright;
Simple assembly, no tools required;
Used for hanging RG20 bins;
Compatible with all brands of plastic bins offered on the market that are equipped with a hanging lip.

Back	W x H	Side	D x H
SH65-3621	36" x 21"	SH66-1221	12" x 21"
SH65-3633	36" x 33"	SH66-1233	12" x 33"
SH65-4221	42" x 21"	SH66-1821	18" x 21"
SH65-4233	42" x 33"	SH66-1833	18" x 33"
SH65-4821	48" x 21"	SH66-2421	24" x 21"
SH65-4833	48" x 33"	SH66-2433	24" x 33"



Plastic Bin



RG20

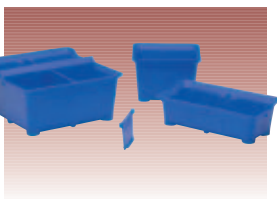

Makes storing, moving and inventory of small parts easier. Lightweight and resistant;
Edge at 45° angle for easy identification and easy removal of parts;
Compatible with louvered panels (SH65, SH66, WM55) and plastic bin rails (SH62 and WM28);
6" bins can be partitioned.

Dimensions			Bin	Product # Partition	Divider
W	D	H			
4"	3"	2"	RG20-040302	-	-
6"	3"	2"	RG20-060302	RG22-0302	-
6"	6"	2"	RG20-060602	RG22-0602	RG24-0602
4"	3"	3"	RG20-040303	-	-
6"	3"	3"	RG20-060303	RG22-0303	-
6"	6"	3"	RG20-060603	RG22-0603	RG24-0603

Vinyl Rub-on Identification Decal

WM91



Allows you to easily identify where tools are to be positioned on the perforated panel (SH38);
The contrasting color provides fast retrieval and shows if tools are missing, and which ones;
Sold in rolls 2 feet wide and 8 feet long.

Product #
WM91-01J

Plastic Bin Rail

SH62

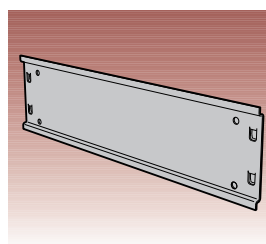

Very useful at ends of aisles. Fast hook-on assembly;
Ideal for all brands of bins from 5" to 7" high;
Bins sold separately.

Product #	Depth
SH62-18	18"
SH62-24	24"

Industrial Shelving Accessories

Multiple Tool Holder

WM94

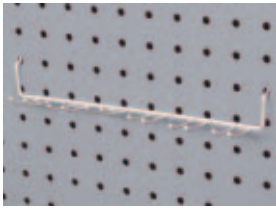

Used for SH38 perforated panels to hang tools.

Product #	W x H
WM94-01	9" x 1 1/2"

Screwdriver Holder

WM95

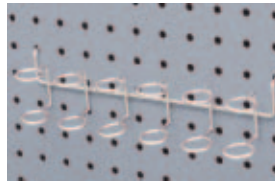

Used for SH38 perforated panels to hang screwdrivers;
May store up to 6 screwdrivers.

Product #	W x D x H
WM95-01	9" x 1 1/2" x 1 3/4"

Straight Arm Hooks

WM96

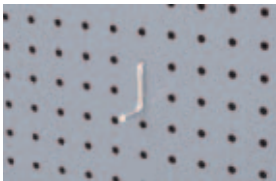

Used for SH38 perforated panels to hang accessories or tools;
Sold in packs of 20.

Product #	Depth
WM96-150	1 1/2"

Single Loop Hooks

WM97



Used for SH38 perforated panels to hang accessories or tools;
Sold in packs of 20.

Product #	Diameter
WM97-150	1 1/2"
WM97-200	2"

Double Back Single Hooks

WM98



Used for SH38 perforated panels to hang accessories or tools;
Sold in packs of 10.

Product #	Depth
WM98-03	3"
WM98-05	5"

Double Back Double Hooks

WM99



Used for SH38 perforated panels to hang accessories or tools;
Sold in packs of 10.

Product #	Depth
WM99-03	3"
WM99-05	5"

NOTE Compatible with perforated panels with 1/4" holes at every 1" c/c. These panels are among the most popular on the market.

Flipper Door

SH85



Full-width handle;
Standard lock included;
14" high door that will allow you to store folders. Also available : 16" high door which will allow you to store binders;
Installs between 2-SH20 shelves;
SH52 dividers can be installed;
Door heights available : 14", 16", 17" and 18";
Order by adding the door height to the part #.
Ex. : SH85-361816L3.

Product #	Width
SH85-3618_L3	36"
SH85-4218_L3	42"
SH85-4818_L3	48"
SH85-3624_L3	36"
SH85-4224_L3	42"
SH85-4824_L3	48"



SHQ0013
Unit with closed welded upright

SHQ0014
Unit with SH37 finishing panel

SHQ0015
Unit with SH38 perforated panel

SPIDER®
SHELVING SYSTEM

Doors

SH40

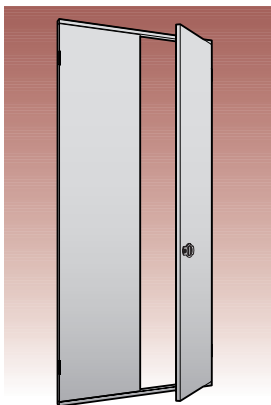

Doors open 180°, with recessed lock and handle;
Simple and fast assembly;
Frame spaced to allow for installation of Rousseau modular drawers;
Compatible with Rousseau Spider® shelving only.

Product #	W x H
SH40-3639L3	36" x 39"
SH40-3675L3	36" x 75"
SH40-3687L3	36" x 87"
SH40-3699L3	36" x 99"
SH40-4239L3	42" x 39"
SH40-4275L3	42" x 75"
SH40-4287L3	42" x 87"
SH40-4299L3	42" x 99"
SH40-4839L3	48" x 39"
SH40-4875L3	48" x 75"
SH40-4887L3	48" x 87"
SH40-4899L3	48" x 99"



SHQ0010

Glass Doors

SH42

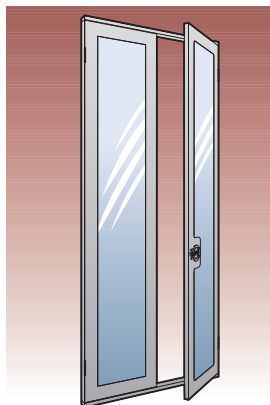

Doors with glass panels ensure you can see contents;
Surface made of polycarbonate with excellent impact resistance;
Doors open 180°, with recessed lock and handle;
Simple and fast assembly;
Frame spaced to allow for installation of Rousseau modular drawers;
Compatible with Rousseau Spider® shelving only.

Product #	W x H
SH42-3639L3	36" x 39"
SH42-3675L3	36" x 75"
SH42-3687L3	36" x 87"
SH42-3699L3	36" x 99"
SH42-4239L3	42" x 39"
SH42-4275L3	42" x 75"
SH42-4287L3	42" x 87"
SH42-4299L3	42" x 99"
SH42-4839L3	48" x 39"
SH42-4875L3	48" x 75"
SH42-4887L3	48" x 87"
SH42-4899L3	48" x 99"



SHQ0011 SHQ0012

Miscellaneous Rails

Clothes Hanging Rail

SH70

Spool Support

SH72

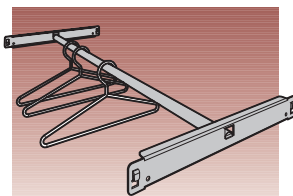

80 lb capacity per rail;
Simple and fast installation;
Installs by hooking to the shelving posts;
Includes one bar with a 1" diameter and 2 adaptors ;
Note : Because of space required under the clothes rail, it is not recommended for use on two-level shelving installations.

Product #	W x D
SH70-3618	36" x 18"
SH70-3624	36" x 24"
SH70-4218	42" x 18"
SH70-4224	42" x 24"
SH70-4818	48" x 18"
SH70-4824	48" x 24"

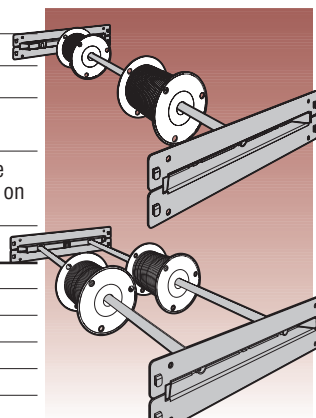

Optimizes storage of spools in shelving;
Offered with one or two rails;
50 lb capacity per rail, 100 lb total per double rail;
Rail(s) with 3/4" diameter, compatible with most spools;
Design allows for pivoting of rail to facilitate changing spools;
Combinations possible for different sized spools.

Product #	W x D	# of Rails
SH72-3612-01	36" x 12"	1 rail
SH72-3618-01	36" x 18"	1 rail
SH72-3618-02	36" x 18"	2 rails
SH72-3624-01	36" x 24"	1 rail
SH72-3624-02	36" x 24"	2 rails
SH72-4212-01	42" x 12"	1 rail
SH72-4218-01	42" x 18"	1 rail
SH72-4218-02	42" x 18"	2 rails
SH72-4224-01	42" x 24"	1 rail
SH72-4224-02	42" x 24"	2 rails
SH72-4812-01	48" x 12"	1 rail
SH72-4818-01	48" x 18"	1 rail
SH72-4818-02	48" x 18"	2 rails
SH72-4824-01	48" x 24"	1 rail
SH72-4824-02	48" x 24"	2 rails

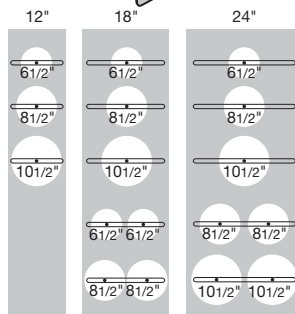

IMPORTANT

For two-level shelving installations, be sure to respect the maximum distance between shelves.

Industrial Shelving Accessories

Modular Drawers and Drawer Accessories

Heavy-Duty Modular Drawer for Shelving

RF32

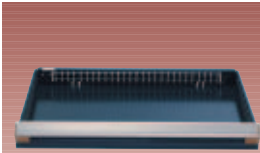

400 lb capacity, 100% extension;
Heavy-duty construction;
Easy to install;

Vast choice of accessories offered to adapt to your storage needs;

Available drawer heights : 3", 4", 5", 6", 7", 8", 9", 10", 12" and 14";

Order by adding the drawer height to the part #.
Ex. : RF32-362406;

For modular drawers with layouts,

SEE PAGES 143-147

SEE PAGES 129-142

Product #	W x D
RF32-3618	36" x 18"
RF32-3624	36" x 24"
RF32-4218	42" x 18"
RF32-4224	42" x 24"
RF32-4818	48" x 18"
RF32-4824	48" x 24"

Heavy-Duty Front Access Roll-Out Shelf

RF41



400 lb capacity, 100% extension;
Heavy-duty construction;
Easy to install;

Painted steel with 3" edges on sides and back;

Height : 6";

Full access to contents.

Product #	W x D
RF41-3618	36" x 18"
RF41-3624	36" x 24"
RF41-4218	42" x 18"
RF41-4224	42" x 24"
RF41-4818	48" x 18"
RF41-4824	48" x 24"

Heavy-Duty 3-Sided Access Roll-Out Shelf

RF45



400 lb capacity, 100% extension;
Heavy-duty construction;

Easy to install;

Galvanized steel with 1 1/2" edge on back;

Height : 5";

May serve as work surface.

Product #	W x D
RF45-3618	36" x 18"
RF45-3624	36" x 24"
RF45-4218	42" x 18"
RF45-4224	42" x 24"
RF45-4818	48" x 18"
RF45-4824	48" x 24"

Mounting Brackets for Spider® Shelving

RE30

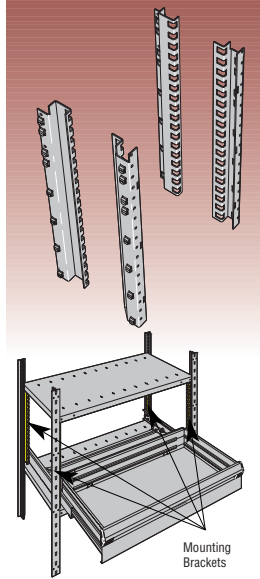

Easy hook-on assembly;

Standard heights : 18", 24", 30", 34", 36", 46" and 48";

The mounting bracket kit is compatible with all drawer widths for Rousseau shelving (36", 42" and 48");

Each kit includes 2 front and 2 rear mounting brackets and all necessary hardware;

Holes at every 1" c/c for drawer adjustment;

Two mounting bracket sets may be stacked simply by installing a shelf between them;

34" high mounting brackets are used with 39" posts or doors;

To order mounting brackets of non-standard heights, contact our customer service representative.

Product #	Height
RE30-18	18"
RE30-24	24"
RE30-30	30"
RE30-34	34"
RE30-36	36"
RE30-46	46"
RE30-48	48"

SEE PAGE 79

Heavy-Duty Front Access Roll-Out Shelf

RF41

Shelving units with drawers must be anchored to the ground.

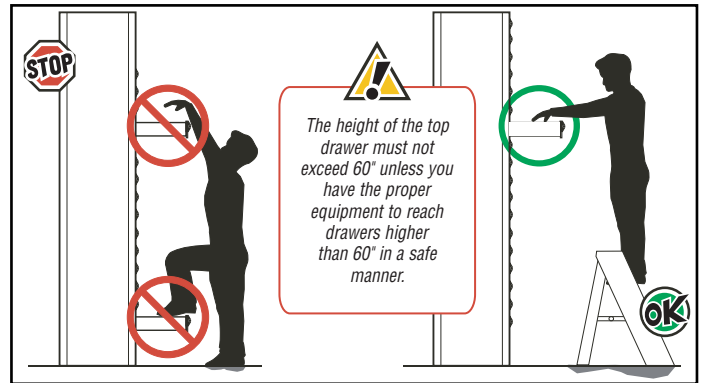

The height of the top drawer must not exceed 60" unless you have the proper equipment to reach drawers higher than 60" in a safe manner.

Heavy-Duty 3-Sided Access Roll-Out Shelf

RF45

Filler

RE90



400 lb capacity, 100% extension;
Heavy-duty construction;

Easy to install;

Galvanized steel with 1 1/2" edge on back;

Height : 5";

May serve as work surface.

Product #	W x D
RF45-3618	36" x 18"
RF45-3624	36" x 24"
RF45-4218	42" x 18"
RF45-4224	42" x 24"
RF45-4818	48" x 18"
RF45-4824	48" x 24"

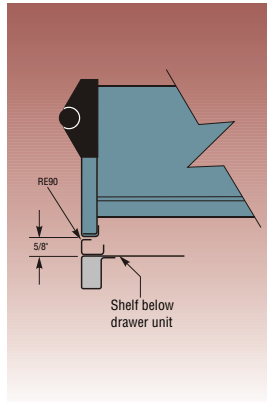

Installs with an adhesive strip under the bank of drawers;

Meets aesthetic requirements of certain work environments (hospitals, offices, etc.);

Offered for Rousseau Spider® shelving only.

Product #	W x H
RE90-3601	36" x 5/8"
RE90-4201	42" x 5/8"
RE90-4801	48" x 5/8"

Vertical Security Bar

RE80



Locks a bank of drawers in shelving with either a key or a padlock;

Safety hasp for padlock is located at the top of the bar to facilitate access;

Covers a bank of drawers from 18" to 48" high;

Easy hook-on assembly;

Possible to install more than one bar on the same bracket for different users;

Installs on the right side;

Offered for Rousseau Spider® shelving only;

36" high bar is compatible with 34" high mounting brackets and 48" high bar is compatible with 46" high mounting brackets;

Order by completing the product number with the type of key.



Product #	Height
RE80-18L3A	18"
RE80-24L3A	24"
RE80-30L3A	30"
RE80-36L3A	36"
RE80-48L3A	48"

Lock-out Mechanism

RF85



For both drawers and roll-out shelves;

Locks drawers and roll-out shelves in open position;

Activated manually, only when required;

No interference with drawer accessories.

Product #

RF85

Drawer Lock

L3



Compatible with all drawer dimensions;

Does not affect usable drawer space;

Easy to retrofit;

Order by adding L3 to drawer or partitioning model number. Ex. : RF32-362406L3.

Product #

L3



Integrated Lock-in Mechanism

PATENTED

A



Activated by tilting the handle up;

Allows user to open the drawer and the roll-out shelf with one hand only;

Close by simply pushing it;

Stops drawer and roll-out shelf from opening on their own;

Easy to retrofit;

Order by adding A to the drawer or partitioning model number or roll-out shelf. Ex. : RF32-362406A.

Product #

A

Econo Lock-in Mechanism

B

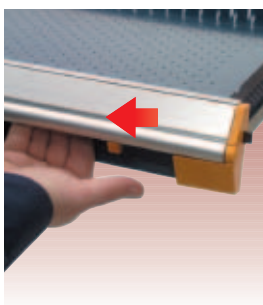

Activated with the right hand by sliding the mechanism with thumb;

Drawer and roll-out shelf closes without having to reactivate the slide mechanism;

Stops drawer and roll-out shelf from opening on their own;

Easy to retrofit;

Order by adding B to the drawer or partitioning model number or roll-out shelf; Ex. : RF32-362406B.

Product #

B

Security Panel

RF91

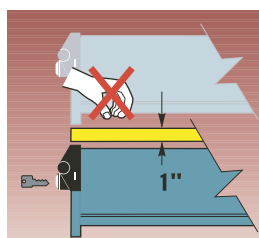

Compatible with vertical security bars and drawer locks;

Blocks access between two drawers or two banks of drawers;

Usable space in the bank of drawers is reduced by 1";

Installed between two drawers.

Product #

W x D

RF91-3618 36" x 18"

RF91-3624 36" x 24"

RF91-4218 42" x 18"

RF91-4224 42" x 24"

RF91-4818 48" x 18"

RF91-4824 48" x 24"

Industrial Shelving Components

Structural Components

Post

SR10/SH10

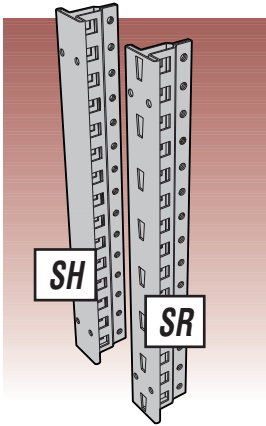

Tubular T-shape; up to 7 fixing zones;
Perforations on sides at every 1" c/c for adjusting shelves;

14 gauge steel;

Choose either :

- The universal SR10 post with the perforated surface to add Mini-Racking or two-level shelving
- The shelving SH10 post with the smooth finish surface for enhanced appearance

SR universal post	SH shelving post	Height
SR10-039	SH10-039	39"
SR10-051	SH10-051	51"
SR10-075	SH10-075	75"
SR10-087	SH10-087	87"
SR10-099	SH10-099	99"
SR10-111	SH10-111	111"
SR10-123	SH10-123	123"

Other dimensions available. Contact your customer service representative.

Welded Open Upright

SR11/SH11

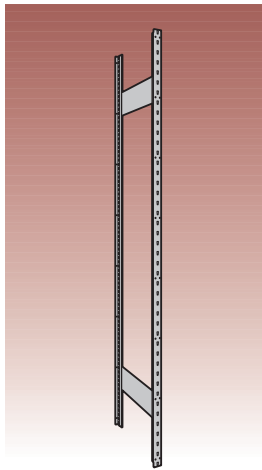

Upright with factory welded side braces;
Fast assembly.

SR universal post	SH shelving post	D x H
SR11-120752	SH11-120752	12" x 75"
SR11-120872	SH11-120872	12" x 87"
SR11-120992	SH11-120992	12" x 99"
SR11-180752	SH11-180752	18" x 75"
SR11-180872	SH11-180872	18" x 87"
SR11-180992	SH11-180992	18" x 99"
SR11-240752	SH11-240752	24" x 75"
SR11-240872	SH11-240872	24" x 87"
SR11-240992	SH11-240992	24" x 99"

Other dimensions available. Contact your customer service representative.

Welded Closed Upright

SR12/SH12

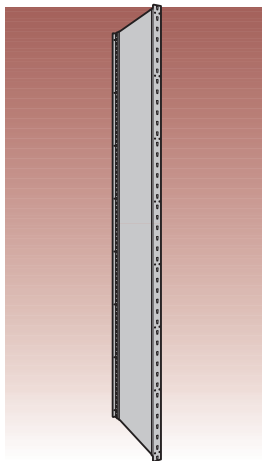

Upright with full-height factory welded parts;
Fast assembly.

SR universal post	SH shelving post	D x H
SR12-12075	SH12-12075	12" x 75"
SR12-12087	SH12-12087	12" x 87"
SR12-12099	SH12-12099	12" x 99"
SR12-18075	SH12-18075	18" x 75"
SR12-18087	SH12-18087	18" x 87"
SR12-18099	SH12-18099	18" x 99"
SR12-24075	SH12-24075	24" x 75"
SR12-24087	SH12-24087	24" x 87"
SR12-24099	SH12-24099	24" x 99"

Other dimensions available. Contact your customer service representative.

Side Braces

SH34

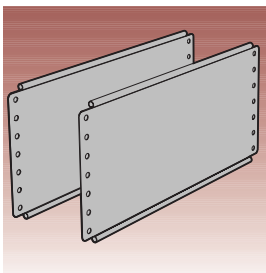

Sold in pairs;

Allow upright assemblies to be fastened in a "ladder-like" manner for easier assembly;

Recommendations :

- 1 pair per upright assembly up to 99" in height
- For upright assemblies over 99" in height, please refer to the S58 technical sheet or contact your customer service representative

Product #	Depth
SH34-12	12"
SH34-15	15"
SH34-18	18"
SH34-24	24"
SH34-30	30"

Back Brace

SH33

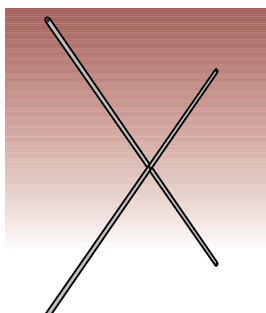

"X" shaped, factory assembled brace;

Easy to install;

Recommendations :

- 1 pair per upright assembly up to 99" in height
- 2 pairs for posts over 99" in height

Product #	Width
SH33-36	36"
SH33-42	42"
SH33-48	48"

Corner Gussets

SH35

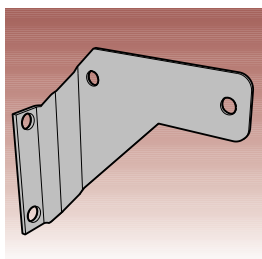

Replace back brace for full access to front and back of shelving unit;

14 gauge steel;

Each set includes 4 gussets. Min. of 3 sets per unit;

Note : Not to be used on units over 99" H or for two-level shelving.

Product #
SH35

Side Panel

SH30

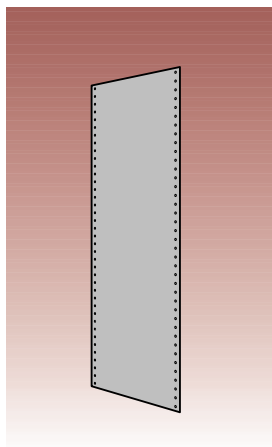

Panel combinations :

- 75"H posts (39" + 39")
- 87"H posts (39" + 51")
- 99"H posts (51" + 51")
- 111"H posts (39" + 39" + 39")
- 123"H posts (39" + 39" + 51")

Product #	D x H
SH30-1239	12" x 39"
SH30-1251	12" x 51"
SH30-1539	15" x 39"
SH30-1551	15" x 51"
SH30-1839	18" x 39"
SH30-1851	18" x 51"
SH30-2439	24" x 39"
SH30-2451	24" x 51"

Back Panel

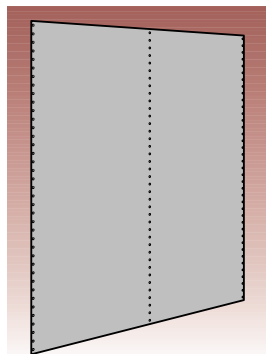

Includes one SH32 back panel hook to stop panel from bowing;



Panel combinations :

- 75"H posts (39" + 39")
- 87"H posts (39" + 51")
- 99"H posts (51" + 51")
- 111"H posts (39" + 39" + 39")
- 123"H posts (39" + 39" + 51")

Product #	W x H
SH31-3639	36" x 39"
SH31-3651	36" x 51"
SH31-4239	42" x 39"
SH31-4251	42" x 51"
SH31-4839	48" x 39"
SH31-4851	48" x 51"

Shelf Front or Front Base

SH28

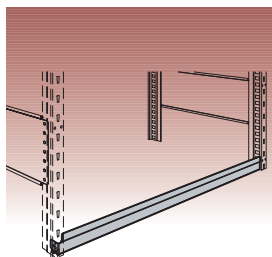

Same component for both applications;
Fast hook-on installation;
Note: Front base is always included with closed shelving models.

Product #	W x H
SH28-3602	36" x 2"
SH28-4202	42" x 2"
SH28-4802	48" x 2"
SH28-3605	36" x 5"
SH28-4205	42" x 5"
SH28-4805	48" x 5"



Installation Accessories

Floor Anchor Plate

SH45

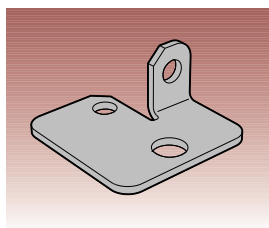

Sold individually;
Attaches to the post for anchoring shelving sections to the floor. Distributes the load on a larger surface and protects the floor;
12 gauge galvanized steel.

Product #
SH45

Floor Anchoring Hardware

SH47

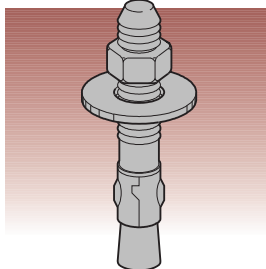

Used for anchoring shelving to the floor;
Includes 4 cement screws.

Product #
SH47-04

Shim Plate

SH46

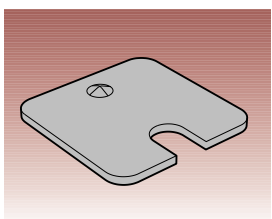

Sold individually;
Evens out shelving units on uneven surfaces. Slides under SH45 floor anchor plate;
12 or 16 gauge galvanized steel.

Product #	Thickness
SH46-12	12 gauge
SH46-16	16 gauge

Wall Spacer

SR47

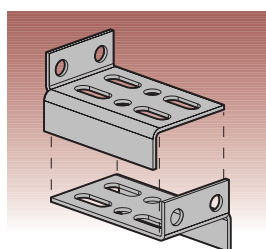

Designed to anchor shelving to the wall;
Adjusts from 3" to 4";
Wall anchoring hardware not included (holes are 5/16" in diameter).

Product #
SR47-0304

Industrial Shelving Components

Shelves and Shelf Accessories

Box Shelf

SH20

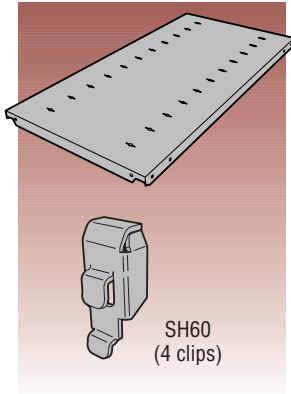

Box-type shelf with front and rear edges roll-formed and welded;
20 gauge steel, 1 1/4" thick;
4 sturdy and compact SH60 clips included;
Perforations for dividers at every 3" c/c;
30" D shelves are also available. For further information regarding additional dimensions, contact your customer service representative.

Product #	W x D
SH20-3612	36" x 12"
SH20-3615	36" x 15"
SH20-3618	36" x 18"
SH20-3624*	36" x 24"
SH20-4212	42" x 12"
SH20-4215	42" x 15"
SH20-4218	42" x 18"
SH20-4224	42" x 24"
SH20-4812	48" x 12"
SH20-4815	48" x 15"
SH20-4818	48" x 18"
SH20-4824	48" x 24"

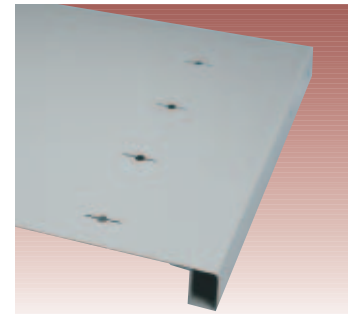

* Also offered with a double fold on the sides.

SPIDER®
SHELVING SYSTEM

Shelf Load Capacity

Shelving load capacity tests are based on ANSI MH28.1 Shelving Manufacturer Association (SMA) standards. Capacities incorporate a safety factor and are valid for an equally distributed load. Capacities are indicated in pounds.

** 800 lb capacity with SH22 side shelf reinforcers or shelf with double fold on the side.

Dimensions W x D	Medium-Duty Capacity	Heavy-Duty Capacity	Extra Heavy-Duty Capacity
	Without Reinforcer	Central Reinforcer	Double Reinforcer
36" x 12"	750	—	—
36" x 15"	775	—	—
36" x 18"	800	1000	1100
36" x 24"	625**	1050	1100
42" x 12"	650	—	—
42" x 15"	650	—	—
42" x 18"	650	850	1050
42" x 24"	650	875	1050
48" x 12"	550	—	—
48" x 15"	550	—	—
48" x 18"	575	725	1025
48" x 24"	600	750	1050

Front Shelf Reinforcer

SH24

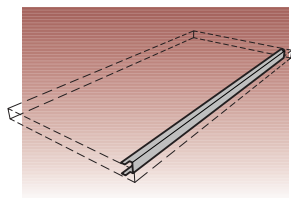

"C" shaped reinforcer. Used when shelves must support heavier loads in front. Note : The reinforcer increases shelf sturdiness, not capacity.

Product #	Width
SH24-36	36"
SH24-42	42"
SH24-48	48"

Side Shelf Reinforcers

SH22

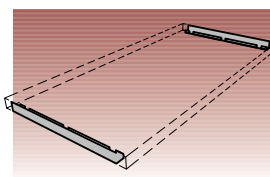

2 "L" shaped reinforcers for attachment on each side of a shelf. Used when shelves must support heavier loads.

Product #	Depth
SH22-18	18"
SH22-24	24"

Double Shelf Supports

SH25

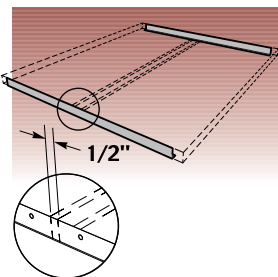

2 "L" shape supports. Used with two 15" shelves to obtain 30" depth (1/2" gap between shelves);

Total capacity : 750 lb.

Product #	Depth
SH25-30	30"

Center Shelf Reinforcer

SHC

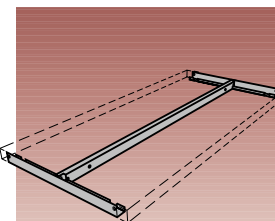

SH24 front shelf reinforcer combined with SH22 side reinforcers. Used when shelves must support heavier or more concentrated loads;

Note : An additional SH24 reinforcer should be ordered to obtain extra heavy-duty shelf capacity.

Product #	W x D
SHC1003	36" x 18"
SHC1004	36" x 24"
SHC1007	42" x 18"
SHC1008	42" x 24"
SHC1005	48" x 18"
SHC1006	48" x 24"